

RR01V96W

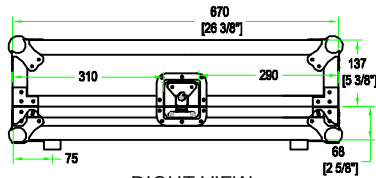

RIGHT VIEW

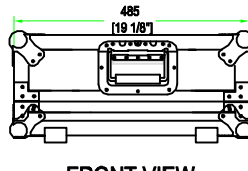

FRONT VIEW

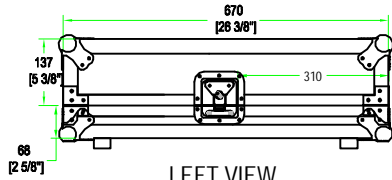

LEFT VIEW

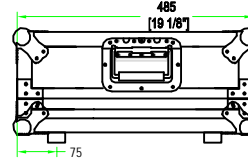

BACK VIEW

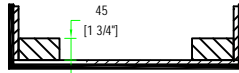

C-C VIEW

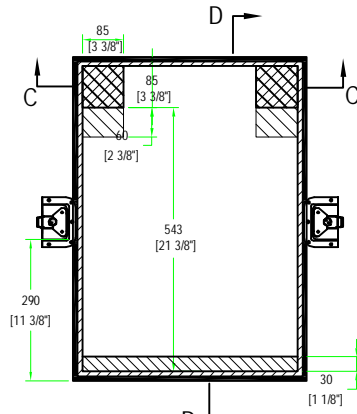

TOP VIEW OF COVER

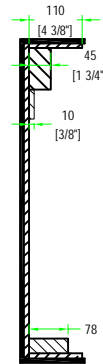

D-D VIEW



A-A VIEW

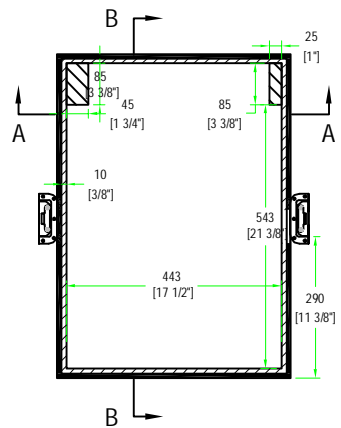

TOP VIEW OF BASE



B-B VIEW

Signature of Approval

Printed Name

2010-04-07